

Ürün katalođu

Wavin AS+

Üst segment
sessiz atık su sistemi



wavin





Wavin, Türkiye'deki plastik boru sektörünün lider firmalardan biridir. Şirketimiz, inşaat ve alt yapıya yönelik geniş yelpazede ve yüksek kalitede boru ve ek parça sistem çözümleri sunmaktadır. Yarım asra yakın bir geçmişe sahip olan şirketimiz, 1971 yılında Adana'da kurulmuştur. 2008 yılına kadar Sabancı Holding bünyesinde Pilsa Plastik A.Ş. olarak faaliyet göstermiş, bu tarihten sonra ise merkezi Hollanda'da bulunan kendi alanında Avrupa'nın en büyüğü Wavin B.V tarafından satın alınmıştır.

2012 yılında ise tüm Wavin şirketleri, Güney Amerika'nın dev petrokimya ve hammadde üreticisi Mexichem ailesine dahil olmuştur. 2019 yılında ise bağlı olduğumuz topluluk, isim değişikliğine giderek yeni ismini ORBIA olarak duyurmuştur. ORBIA, yeni değişen yapısıyla birlikte dünya genelinde, İnşaat & Alt yapı, Flor, Datacom, Hassas Tarım ve Polimer Çözümleri olmak üzere 5 ana iş kolunda ürün ve hizmetleriyle müşterilerine profesyonel destek vermektedir. ORBIA'nın yeni yapılanmasıyla birlikte ana misyonu dünyanın her yerinde hayatı ileriye taşımaktır.

2019 yılında ORBIA'nın yenilenen iş yapısıyla beraber inşaat ve alt yapı iş kolu, tüm dünyada tek ve güçlü bir marka olan WAVIN ile temsil edilmeye başlanmıştır. WAVIN, Dünyada 40'tan fazla ülkede, Avrupa-Ortadoğu-Afrika, Asya-Pasifik, Latin Amerika ve ABD-Kanada olmak üzere 4 ana bölgede, 12 bin çalışan ile faaliyet göstermektedir.

Wavin Türkiye, PPR-C temiz su, PVC atık su gibi geleneksel boru sistemlerinin yanında Tigris Pres-fit sistemler, SiTech+ sessiz boru sistemleri, QuickStream sifonik yağmur suyu tahliye sistemleri, QBic Plus infiltrasyon sistemleri, Tegra plastik menholler ve bunun gibi birçok yenilikçi ürünü sektöre sunmaktadır. 2014 yılında Adana'daki fabrikamız bünyesinde açılan Wavin Academy, sektörün ilk eğitim merkezi olma özelliğine sahiptir. 2014 yılından beri mekanik tesisat sektörünün çeşitli kademelerinde çalışan on binlerce ziyaretçi, Wavin Academy'de gerçekleşen eğitimlere katılarak uzmanlık bilgilerini artırmayı başardılar. Şirketimiz Adana, İstanbul, Ankara ve İzmir'de yer alan Bölge Müdürlükleri, Adana ve İstanbul'daki dağıtım merkezleri ve geniş bayi ağıyla tüm Türkiye'ye hızlı servis sağlamaktadır. Satış kadromuzun yanı sıra, konusunda uzman mühendis ve teknik personelimiz projelerde müşterilerimize destek olmaktadır.

Şirketimiz ve ürünlerimizle ilgili daha ayrıntılı bilgi alabilmek için www.wavin.com.tr web sitemizi ziyaret edebilir ve Wavin Türkiye sosyal medya hesaplarımızdan bizi takip edebilirsiniz.



Wavin AS+ Teknik Bilgiler

Wavin AS+, mineral katkılı polipropilen (PP) hammaddeden imal edilen sessiz atık su sistemidir. Eşsiz hammadde bileşenleri sayesinde sessizlik performansı geliştirilmiştir. Hammaddenin yüksek yoğunluğu sayesinde ideal sessizlik sağlanmıştır. Ayrıca 3 katmanlı boru yapısı ve muflu bağlantılar için geliştirilen kendinden kaydırıcılı özel elastomerik (EPDM) conta sistemi sayesinde uygulama kolay, hızlı ve güveniliridir.

Hammadde

Mineral katkılı polipropilen

Teknik Özellikler

Yoğunluk	~ 1,9 g/cm ³
Elastiklik Modülü (E-Modül)	~ 1800 N/mm ²
Termal genleşme katsayısı	~ 0,06 mm/mK
Yangın sınıfı	DIN 4102, B2 ve EN13501 D-S3, d0
Kullanım sıcaklığı	Kısa süreli 95°C ve Uzun süreli 90°C

Renk

Açık gri RAL 7035

Boyutsal Özellikler

DN	d ¹⁾	di ²⁾	s ³⁾
50	50	44	3,0
70	75	68	3,5
90	90	80,8	4,6
100	110	99,4	5,3
125	125	114,4	5,3
150	160	148,8	5,6
200	200	188	6,0

¹⁾ Dış çap (mm)

²⁾ İç çap (mm)

³⁾ Et Kalınlığı (mm)

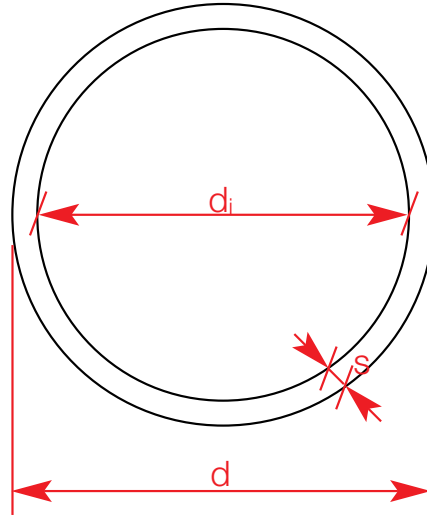

Boru Markalaması

Wavin AS+, çap, tarih, sertifika işaretleri, hammadde, yangın sınıfı

Örnek: Wavin AS+, DN 100, tarih, Z.-42.1-569, (mineral katkılı PP) Ü DIN 4102, B2

Wavin AS+ Ürün Portföyü

* 2020 İLK ÇEYREKTEN SONRA MEVCUT OLACAK

* 2020 İLK ÇEYREKTEN SONRA MEVCUT OLACAK

	DN 50	DN 70	DN 90	DN 100	DN 125	DN 150	DN 200
Boru 	✓	✓	✓	✓	✓	✓	✓
Manşon 	✓	✓	✓	✓	✓	✓	✓
Dirsek 	✓	✓	✓	✓	✓	✓	✓
Uzun Dirsek 			✓	✓			
Sifon Dirsek 	✓						
Düz Sifon	✓						
Tek Çatal 	✓	✓	✓	✓	✓	✓	✓
Çift Çatal 			✓	✓			
Köşe Çatalı 			✓	✓			
Paralel Çatal 			✓	✓			
Çift Yönlü Çatal 				✓			
Duş Çatalı 			✓	✓			
Kayar Manşon 	✓	✓	✓	✓	✓	✓	✓

* 2020 İLK ÇEYREKTEN SONRA
MEVCUT OLACAK

* 2020 İLK ÇEYREKTEN SONRA
MEVCUT OLACAK

		DN 50	DN 70	DN 90	DN 100	DN 125	DN 150	DN 200
Tamir Manşonu		✓	✓	✓	✓	✓	✓	✓
Kör Tapa		✓	✓	✓	✓	✓	✓	✓
Redüksiyon			✓	✓	✓	✓	✓	✓
Temizleme Kapağı		✓	✓	✓	✓	✓	✓	✓
Sessiz Boru Kelepçesi		✓	✓	✓	✓	✓	✓	✓
LKS Kelepçe		✓	✓	✓	✓	✓	✓	✓
EPDM Conta		✓	✓	✓	✓	✓	✓	✓
NBR Conta		✓	✓	✓	✓	✓	✓	✓
Kauçuk Sifon Contası 1 1/2" 53mm								
Kauçuk Sifon Contası 1 1/4" 53mm								
Yangın Kelepçesi BM-R90		✓	✓	✓	✓	✓	✓	✓
EPDM Esnek Bağlantı Manşonu (AS >AS+)		✓	✓			✓		

Wavin AS+ Ürün Portföyü

BORU

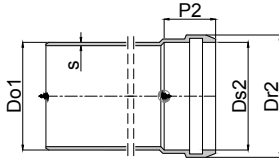

DN	Dış çap Do1 = Ds2	Et kalınlığı (S)	Muf boyu (P2)
50	50	3,0	46
70	75	3,5	51
90	90	4,6	55
100	110	5,3	59
125	125	5,3	63
150	160	5,6	71
200	200	6,0	86

Wavin AS+ Boru - Muf

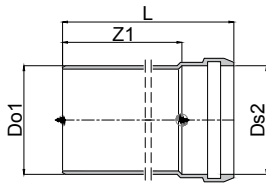

Çap DN	SAP Kodu	Do1 mm	L mm	Ds2 mm	Z1 mm	Ağırlık kg/PC
50	3080057	50	198	50	150	0,180
50	3080058	50	298	50	250	0,262
50	3080059	50	546	51	500	0,437
50	3080060	50	1046	51	1000	0,825
50	3080061	50	2046	51	2000	1,605
50	3080062	50	2746	51	2700	2,150
50	3080063	50	3046	51	3000	2,383
70	3080064	75	202	75	150	0,297
70	3080065	75	302	75	250	0,442
70	3080066	75	551	76	500	0,787
70	3080067	75	1051	76	1000	1,490
70	3080068	75	2051	76	2000	2,896
70	3080069	75	2751	76	2700	3,880
70	3080070	75	3051	76	3000	4,302
90 *	3080071	90	205	90	150	0,465
90 *	3080072	90	305	90	250	0,692
90 *	3080073	90	554	91	500	1,250
90 *	3080074	90	1054	91	1000	2,366
90 *	3080075	90	2054	91	2000	4,597
90 *	3080076	90	2754	91	2700	6,160
90 *	3080077	90	3054	91	3000	6,829
100	3080030	110	209	111	150	0,675
100	3080031	110	309	111	250	1,017
100	3080032	110	559	111	500	1,830
100	3080033	110	1059	111	1000	3,407



Çap DN	SAP Kodu	Do1 mm	L mm	Ds2 mm	Z1 mm	Ağırlık kg/PC
100	3080034	110	2059	111	2000	6,562
100	3080035	110	2759	111	2700	8,770
100	3080036	110	3059	111	3000	9,716
125	3080037	125	213	125	150	0,788
125	3080038	125	313	125	250	1,155
125	3080039	125	562	126	500	2,092
125	3080040	125	1062	126	1000	3,895
125	3080041	125	2062	126	2000	7,502
125	3080042	125	2762	126	2700	10,026
125	3080043	125	3062	126	3000	11,109
150	3080044	160	221,4	160	150	1,088
150	3080045	160	321,4	160	250	1,088
150	3080046	160	570,2	161	500	2,865
150	3080047	160	1070	161	1000	5,334
150	3080048	160	2070	161	2000	10,272
150	3080049	160	2770	161	2700	13,730
150	3080050	160	3070	161	3000	15,211
200 *	3080051	200	328	201	250	2,05
200 *	3080052	200	584	201	500	4,145
200 *	3080053	200	1084	201	1000	7,488
200 *	3080054	200	2084	201	2000	14,172
200 *	3080055	200	2784	201	2700	18,852
200 *	3080056	200	3084	201	3000	20,857

* 2020 ilk çeyreğinden sonra mevcut

EK PARÇALAR

Wavin AS+ Manşon

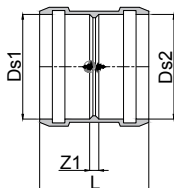

Çap DN	SAP Kodu	L mm	Ds1 mm	Ds2 mm	Z1 mm	Ağırlık kg/PC
50	3080016	99	50	50	3	0,123
70	3080017	107	75	75	3	0,174
90 *	3080018	114	90	90	3	0,263
100	3080012	124	111	111	5	0,391
125	3080013	132	125	125	5	0,512
150	3080014	148	160	160	5	0,755
200 *	3080015	181	201	201	8	1,327

* 2020 ilk çeyreğinden sonra mevcut

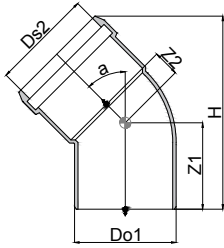

Wavin AS+ Dirsek > 15°, 30°, 45°, 67°, 87°

Çap DN	a	SAP Kodu	Do1 mm	Ds2 mm	Z1 mm	Z2 mm	h mm	Ağırlık kg/PC
50	15°	3079965	50	50	53	11	115	0,108
50	30°	3079966	50	51	57	13	122	0,115
50	45°	3079967	50	51	60	18	126	0,124
50	67°	3079968	50	51	68	23	124	0,130
50	87	3079969	50	51	74	32	111	0,146
70	15°	3079970	75	75	59	11	129	0,179
70	30°	3079971	75	75	64	15	141	0,193
70	45°	3079972	75	75	70	21	150	0,217
70	67°	3079973	75	75	79	29	150	0,229
70	87°	3079974	75	75	90	41	141	0,251
90 *	15°	3079975	90	90	64	15	141	0,299
90 *	30°	3079976	90	90	70	20	157	0,324
90 *	45°	3079977	90	91	73	25	167	0,364
90 *	67°	3079978	90	90	88	37	172	0,390
90 *	87°	3079979	90	90	101	49	160	0,428
100	15°	3079950	110	110	70	17	157	0,466
100	30°	3079951	110	110	77	20	177	0,517
100	45°	3079952	110	110	85	32	192	0,565
100	67°	3079953	110	110	99	44	197	0,606
100	87°	3079954	110	110	114	61	186	0,694
125	15°	3079955	125	125	75	17	167	0,568
125	30°	3079956	125	125	83	25	191	0,628
125	45°	3079957	125	125	92	34	208	0,632
125	87°	3079958	125	125	126	67	206	0,864
150	15°	3079959	160	160	85	19		0,852
150	30°	3079960	160	160	96	28		0,950
150	45°	3079961	160	160	108	42		1,075
150	87°	3079962	160	160	151	84		1,384
200 *	45°	3079963	200	201	132	51		1,814
200 *	87°	3079964	200	201	185	42		2,314

* 2020 ilk çeyreğinden sonra mevcut



Wavin AS+ Uzun Dirsek > 45°

Çap DN	SAP Kodu	Do1 mm	Ds2 mm	Z1 mm	h mm	Ağırlık kg/PC
90 *	3080027	90	90	250	25	0,807
100	3080026	110	110	250	25	1,137

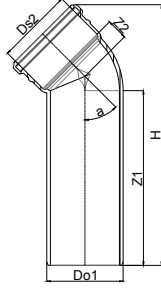

* 2020 ilk çeyreğinden sonra mevcut



Wavin AS+ Sifon Dirsek

Çap DN	a	SAP Kodu	Do1 mm	Ds2 mm	Z1 mm	Z2 mm	h mm	Ağırlık kg/PC
50	87°	3080101	50	53	79	35	123	0,051

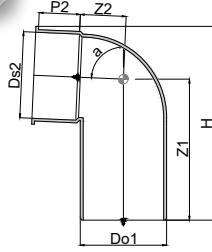

Wavin AS+ Düz Sifon

Çap DN	a	SAP Kodu	Do1 mm	Ds2 mm	Z1 mm	Z2 mm	h mm	Ağırlık kg/PC
50		3080102	50	53	55	40	120	0,051

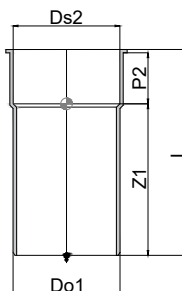



Wavin AS+ Tek Çatal > 45° ve 87°

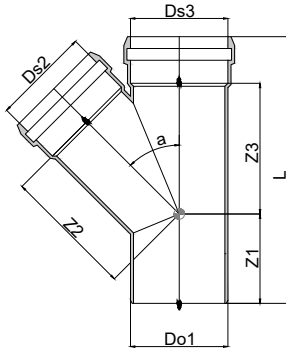

Çap DN	a	SAP Kodu	Do1 mm	L mm	Ds2 mm	Ds3 mm	Z1 mm	Z2 mm	Z3 mm	Ağırlık kg/PC
50/50	45°	3079996	50	171	50	50	60	62	62	0,250
	87°	3079997	50	150	50	50	75	29	29	0,202
70/50	45°	3079998	75	178	50	75	52	82	78	0,336
	87°	3079999	75	158	50	75	78	42	30	0,291
70/70	45°	3080000	75	215	75	75	69	95	95	0,442
	87°	3080001	75	183	75	75	90	45	42	0,343
90/50 *	45°	3080002	90	185	50	90	55	93	77	0,487
	87°	3080003	90	186	50	90	82	52	30	0,432
90/70 *	45°	3080004	90	220	75	90	65	106	103	0,610
	87°	3080005	90	191	75	90	93	49	45	0,495
90/90 *	45°	3080006	90	243	90	90	76	114	114	0,757
	87°*	3080007	90	224	90	90	124	68	48	0,646
100/50	45°	3079982	110	197	50	110	59	106	81	0,689
	87°	3079983	110	178	50	110	85	59	36	0,637
100/70	45°	3079984	110	230	75	110	59	120	114	0,836
	87°	3079985	110	200	75	110	97	59	46	0,695
100/90	45°	3079986	110	249	90	110	69	128	123	0,986
	87°	3079987	110	216	90	110	105	60	55	0,791
100/100	45°	3079981	110	277	111	110	83	194	138	1,216
	87°*	3079980	110	253	110	110	136	77	56	1,061
125/100	45°	3079988	125	291	110	125	81	152	149	1,410
	87°	3079989	125	241	110	125	118	70	63	1,056
125/125	45°	3079990	125	310	125	125	91	158	158	1,607
150/100	45°	3079991	160	304	110	160	71	175	165	1,822
	87°	3079992	160	256	110	160	124	87	6	1,424
150/125	45°	3079993	160	326	125	160	82	184	176	2,029



Çap DN	a	SAP Kodu	Do1 mm	L mm	Ds2 mm	Ds3 mm	Z1 mm	Z2 mm	Z3 mm	Ağırlık kg/PC
150/150	45°	3079994	160	375	160	160	108	200	199	2,519
200/200	* 45°	3079995	200	460	201	201	128	250	250	4,259

*içerden açılı

* 2020 ilk çeyreğinden sonra mevcut

Wavin AS+ Çift Çatal > 87°



Çap DN	a	SAP Kodu	Do1 mm	L mm	Ds2 mm	Z1 mm	Z2 mm	Z3 mm	Z4 mm	Ağırlık kg/PC
90/90/90*		3080011	90	224	90	124	68	48		0,820
100/100/100*		3080010	110	255	110	139	81	60		1,263

*içerden açılı

* 2020 ilk çeyreğinden sonra mevcut

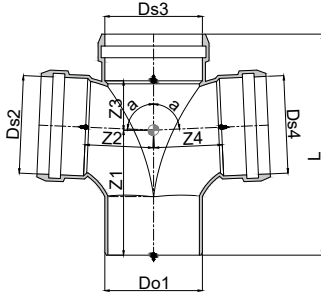

Wavin AS+ Köşe Çatalı > 87°



Çap DN	a	SAP Kodu	Do1 mm	L mm	Ds2 mm	Z1 mm	Z2 mm	Z3 mm	Z4 mm	Ağırlık kg/PC
90/90/90*	87	3080009	90	218	90	111	66	51	51	0,856
100/100/100	87	3080008	110	251	110	122	139	128	139	1,131

* 2020 ilk çeyreğinden sonra mevcut

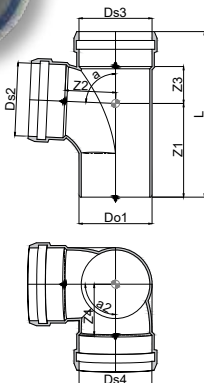



Wavin AS+ Paralel Çatal

Çap DN	SAP Kodu	Do1 mm	L mm	Ds2 Ds3 mm	Z mm	Z1 mm	Z2 mm	Z3 mm	E mm	Ağırlık kg/PC
90/90 *	3080029	90	260	90	151	74	25	118	105	0,684
100/100	3080028	110	303	110	186	87	32	145	130	1,138

* 2020 ilk çeyreğinden sonra mevcut

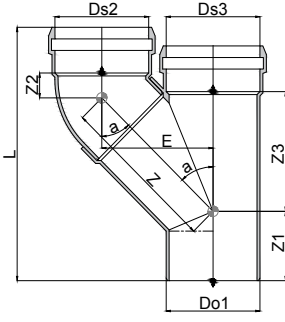

Wavin AS+ Çift Yönlü Çatal

Çap DN	SAP Kodu	Ds1 Ds3 mm	Ds4 mm	Ds2 mm	Z1 mm	Z2 mm	Z3 mm	Z4 mm	Z5 mm	Ağırlık kg/PC
100/100/70	3080109									

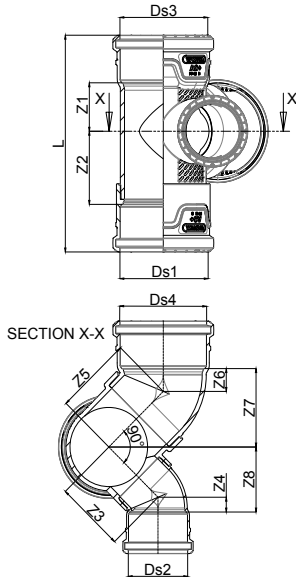



Wavin AS+ Duş Çatalı > 87°

Çap DN	SAP Kodu	Do1 mm	L mm	Ds2 mm	Ds3 mm	Z mm	Z1 mm	Z2 mm	Z3 mm	Ağırlık kg/PC
90/90/50 *	3080098	90	296	50	90	114	82	51	68	1,11
90/90/70 *	3080111	90	296	75	90	114	82	51	68	1,18
100/100/50	3080095	110	330	50	110	126	87	59	81	1,78
100/100/70	3080110	110	330	75	110	126	87	59	81	1,83

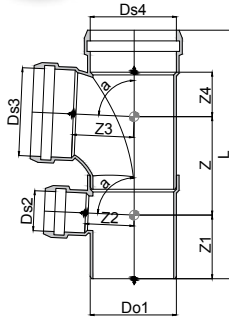

* 2020 ilk çeyreğinden sonra mevcut



Wavin AS+ Duş Çatalı > 87° > sol

Çap DN	SAP Kodu	Do1 mm	L mm	Ds2 mm	Ds3 mm	Z mm	Z1 mm	Z2 mm	Z3 mm	Ağırlık kg/PC
90/90/50 *	3080099	90	296	50	90	114	82	51	68	1,11
100/100/50	3080096	110	330	50	110	126	87	59	81	1,78

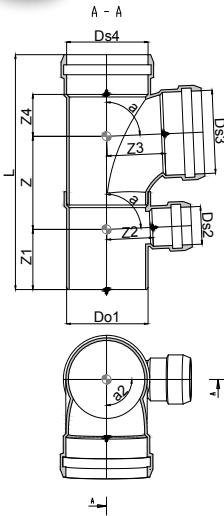

* 2020 ilk çeyreğinden sonra mevcut

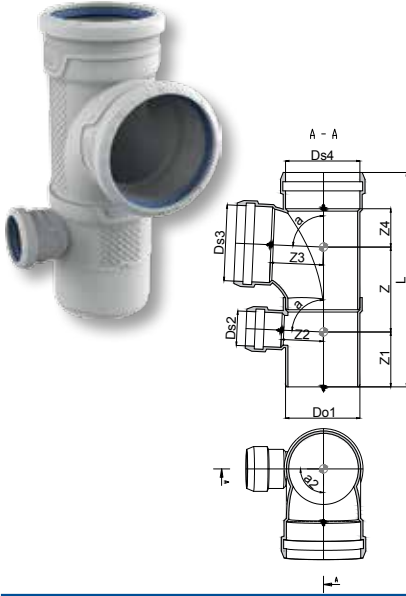

Wavin AS+ Duş Çatalı > 87° > sağ

Çap DN	SAP Kodu	Do1 mm	L mm	Ds2 mm	Ds3 mm	Ds4 mm	Z mm	Z1 mm	Z2 mm	Z3 mm	Z4 mm	Ağırlık kg/PC
90/90/50 *	3080100	90	296	50	90	114	82	51	68	1,11		
100/100/50	3080097	110	330	50	110	126	87	59	81	1,78		

* 2020 ilk çeyreğinden sonra mevcut



Wavin AS+ Kayar Manşon

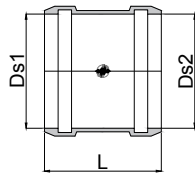

Çap DN	SAP Kodu	L mm	Ds1 mm	Ds2 mm	Ağırlık kg/PC
50	3080092	99	50	50	0,121
70	3080093	107	75	75	0,170
90 *	3080094	114	90	90	0,263
100	3080088	124	110	110	0,387
125	3080089	132	125	125	0,512
150	3080090	148	160	160	0,755
200 *	3080091	181	201	201	

* 2020 ilk çeyreğinden sonra mevcut



Wavin AS+ Tamir Manşonu

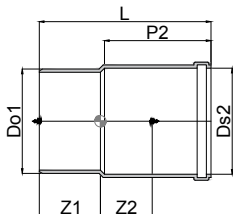

Çap DN	SAP Kodu	Do1 mm	L mm	Ds2 mm	P2 mm	Z1 mm	Z2 mm	Ağırlık kg/PC
50	3080023	50	184	50	105	57	60	0,178
70	3080024	75	199	75	129	62	66	0,268
90 *	3080025	90	202	90	125	66	92	0,421
100	3080019	110	219	110	137	69	88	0,657
125	3080020	125	237	125	148	74	79	0,811
150	3080021	160	264	160	164	85	123	1,183
200 *	3080022							

* 2020 ilk çeyreğinden sonra mevcut

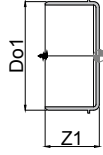

Wavin AS+ Kör Tapa

Çap DN	SAP Kodu	Do1 mm	Z1 mm	Ağırlık kg/PC
50	3080106	50	51	0,055
70	3080107	75	55	0,108
90 *	3080108	90	60	0,186
100	3080103	110	65	0,290
125	3080104	125	68	0,360
150	3080105	160	76	0,565

* 2020 ilk çeyreğinden sonra mevcut

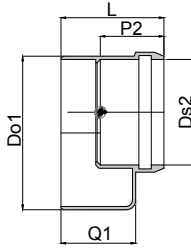

Wavin AS+ Redüsiyon

Çap DN	SAP Kodu	Do1 mm	L mm	Ds2 mm	P2 mm	Q1 mm	Ağırlık kg/PC
70/50	3080085	75	79	51	48	68	0,151
90/50 *	3080086	90	86	51	19	72	0,222
90/70 *	3080087	90	85	76	52		0,193
100/50	3080078	110	90	51	53	79	0,356
100/70	3080079	110	90	76	57	79	0,334
100/90	3080080	110	91	90	61	78	0,328
125/100	3080081	125	99	111	59		0,371
150/100	3080082	160	114	111	59	98	0,691
150/125	3080083	160	114	126	63	98	0,706
200/150 *	3080084	200	130	160	24	114	1,022

* 2020 ilk çeyreğinden sonra mevcut

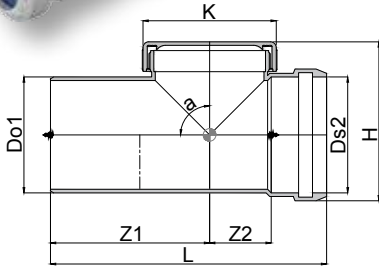

Wavin AS+ Temizleme Kapağı

Çap DN	a	SAP Kodu	Do1 mm	L mm	Ds2 mm	Z1 mm	Z2 mm	K mm	H mm	Ağırlık kg/PC.
50		3079917	50	164	50	82	37	65	84	
70		3079918	75	200	76	97	53	93	111	
90 *		3079949	90	228	90	114	62	111	131	
100		3079913	110	258	110	129	72	130	156	
125		3079914	125	259	125	127	71	130	174	
150		3079915	160	271	160	135	68	130	213	
200 *		3079916								

* 2020 ilk çeyreğinden sonra mevcut

AKSESUARLAR

Wavin AS+ LKS Kelepçe

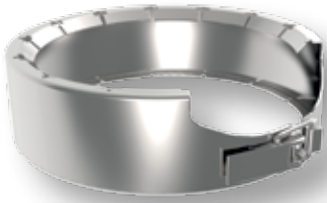

Çap DN	SAP Kodu
50	4065138
70	4065139
90 *	4065140
100	4065141
125	4065142
150	4065143
200 *	4065144

* 2020 ilk çeyreğinden sonra mevcut

Wavin AS+ EPDM Conta



Çap DN	SAP Kodu
50	4065145
70	4065186
90	4065187
100	4065188
125	4065189
150	4065190
200	4065191



Wavin AS+ NBR Conta

Çap DN	SAP Kodu
-----------	----------

50	4065192
70	4065193
90	4065194
100	4025566
125	4025567
150	4025568
200	4025569

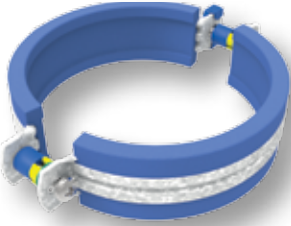

Wavin AS+ Sessiz Boru Kelepçesi

Çap DN	SAP Kodu
-----------	----------

50	4066449
70	4066450
90	4066451
100	4066452
125	4066453
150	4066454
200	4066455



Wavin AS+ Kauçuk Sifon Contası

Çap DN	SAP Kodu
-----------	----------

53 – 1¼"	4024657
53 – 1½"	4024658



Wavin AS+ Yangın Kelepçesi BM-R90

Çap DN	SAP Kodu
-----------	----------

32	4059802
40	4026101
50	4026102
63	4026103
75	4026104
90	4026405
110	4026106
125	4026107
140	4026108
160	4026109
180	4026110
200	4026111



Wavin AS+ EPDM Esnek Bağlantı Manşonu (AS>AS+)

Çap DN	SAP Kodu
-----------	----------

58-50	4066491
78-75	4066492
135-125	4066493

Wavin sound camera take 1224200



Tesisatta mükemmel ses yalıtımı asla tesadüf değildir

Patentli mavi conta sayesinde
kaydırıcı maddeye gerek yok

Sesi hapseden
özel hammadde

Küçük ve dar alanlar için
kompakt tasarım



YENİ Wavin AS+

ÜST SEGMENT
SESSİZ ATIK SU SİSTEMİ

Dalgali spigot uç ile
%50 daha az itme kuvveti

wavin

Ürün portföyümüzü keşfedin

Su Yönetimi

Su ve Gaz Dağıtım

Isıtma ve Soğutma

Atık Su Drenajı



Wavin, dünyanın bazı önemli sorunlarıyla mücadele eden şirketler topluluğu Orbia'nın bir parçasıdır. Ortak bir amaç ile birbirimize bağlıyız: "To Advance Life Around the World"



Wavin TR Plastik Sanayi A.Ş. | Güzelevler Mah.Girme Bulvarı No: 294/A Yüreğir / Adana
Web www.wavin.com.tr | E-mail wavin.tr.info@wavin.com

Wavin, sürekli ürün iyileştirme programı ile hareket eder; bu nedenle ürün teknik özelliklerinde haber vermeden düzeltme ya da değişiklik yapma hakkına sahiptir. Bu dokümandaki bilgiler yararlı kullanım amacıyla ve baskıda doğru bilgilerin yer alacağı düşüncesiyle hazırlanmıştır. Fakat herhangi bir hata, eksiklik ya da yanlış varsayımlardan kaynaklı bir mesuliyet kabul edilmez.

© 2019 Wavin haber vermeksizin her türlü değişiklik için hakkını saklı tutar. Sürekli ürün geliştirme çerçevesinde teknik bilgilerde değişimler olabilir. Uygulama, montaj talimatlarına uygun olarak yapılmalıdır.